



# MOS36K MINIMAL OPENING SYSTEM

**SIMPLE INSTALL,  
HUGE SOUND**

Our smallest yet largest feat so far, the Minimal Opening System™ is a revolutionary fully in-ceiling audio system that mimics the appearance of 4" designer lighting.

Customized to match the unique appearance of home lighting, the custom finish blends seamlessly into the ceiling alongside lights for a sophisticated uniform look.

**PRODUCT ID**



**MOS36K**

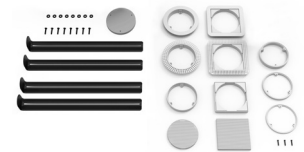

**INCLUDED TRIM RING KIT**



**MOS36BOX**



**MOS36MRM**

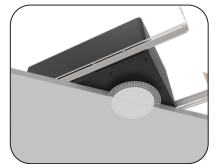
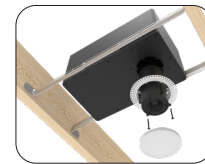
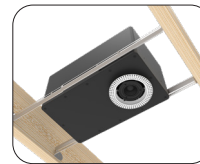

**REVOLUTIONARY  
PRE-CONSTRUCTION  
MOUNTING**

Uniquely engineered to grant a simple installation process, built-in rails secure the subwoofer enclosure into the ceiling, with the exact dimensions to ensure a tight fit between ceiling joists; and then a simple twist & hex screw will lock the Mid-Range speaker into place.

**PREMIUM CHOICE  
TRIM-RINGS**

The included Trim-Ring Kit includes 6 different designs, offering the latest, invisible flushmount trim-ring options, and both round & square grilles, allowing the ideal trim to be selected to match any interior.



# MOS36K SPECIFICATIONS

## SPECIFICATIONS

### MOS36K SYSTEM

System Type	Two-Way Full Range Loudspeaker
Frequency Response	35Hz - 20kHz [ - 10dB] 44Hz - 20kHz [ - 3dB]
Power RMS	75 Watts
Power Peak	200 Watts
Recommended Amp	50W - 150W FTC @ 4 Ω
Crossover	Custom Two-Way Passive 200Hz
Maximum SPL @ 1m	102 dB Continuous, 107 dB Peak
System coverage	100-degree conical
Sensitivity, 1W/1m	84 dB
Nominal Impedance	4 Ω
Input Connectors	2P Phoenix Connector

### PART NUMBER

<b>PART</b>	<b>MOS36BOX</b>
<b>PART NUMBER</b>	<b>MOS3600BOX</b>
Subwoofer Enclosure Mounting	6 1/2" Composite Glass Fiber Composite UL Resin Overlapping Formed Steel Straps, Adjustable from 14.5" – 22.5"
Height	6 3/4" (172 mm)
Width	8" (203 mm)
Depth	14" (356 mm)
Weight	11.5lbs (5.23kg)

### PART NUMBER

<b>PART</b>	<b>MOS36MRM</b>
<b>PART NUMBER</b>	<b>MOS3600MRM</b>
Full Range Driver Components	2" Wide Band Aluminum Cone Rubber Surround Neodymium Transducer
Height	5 1/2" (14 mm)
Diameter	2 13/16" (72 mm)
Weight	0.55lbs (0.25kg)

## LINE DRAWINGS

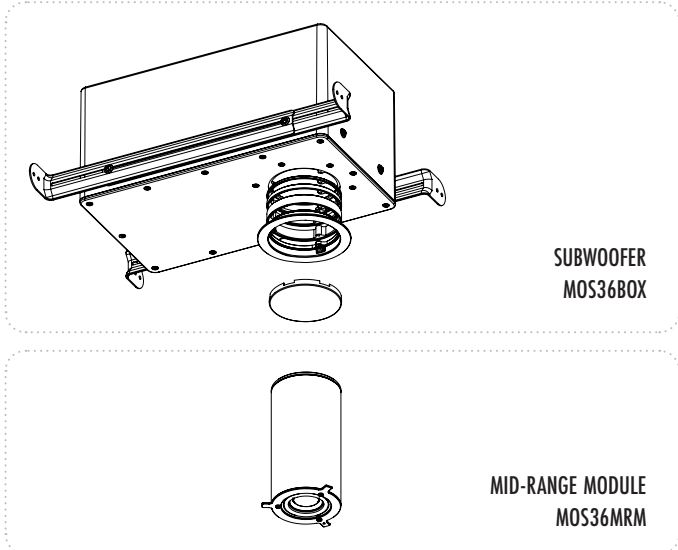

### TRIM-RING KIT:

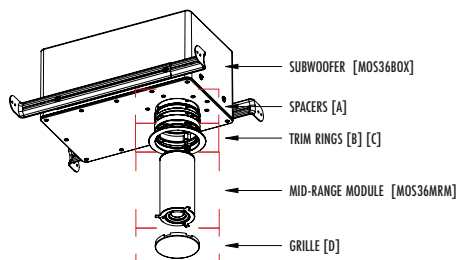
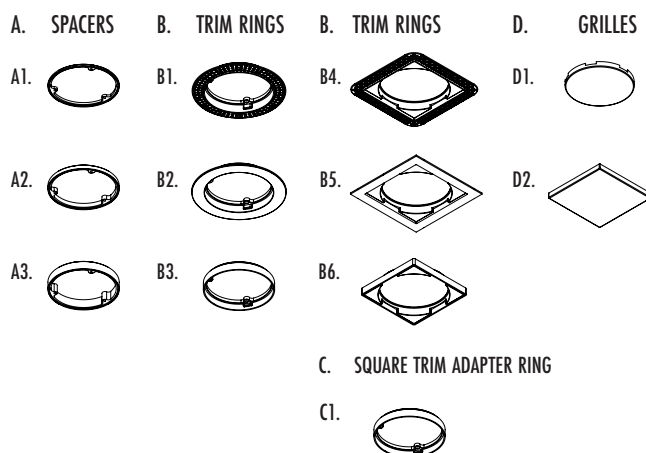

Please visit [docs.originacoustics.com](https://docs.originacoustics.com) or scan the QR code using your smart device for the most up to date specifications and use instructions for this product. Products may only be purchased through an authorized integration partner.